

Zigzags

Keep folding into Quarters

Fold double the other way

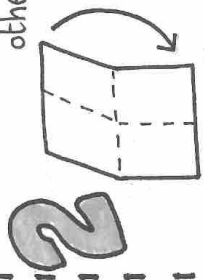

Pictures on the outside again.

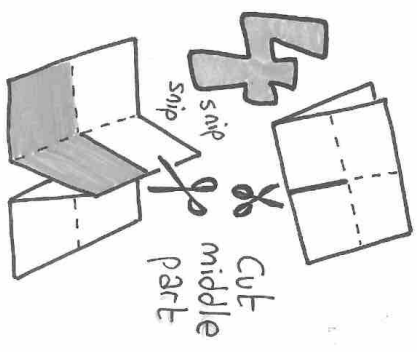
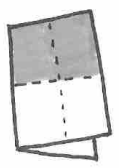

Cut from here to there

Fold the paper length ways



Printing on the outside

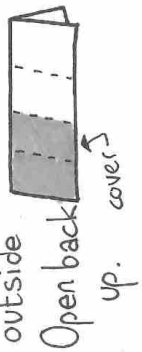

Fold middle bits to either side  
Fold double →  
Fold double ...

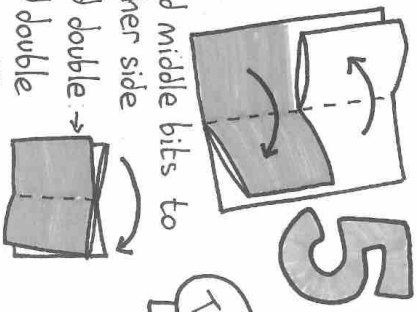

TIP

When designing for photocopier, keep text away from the edge

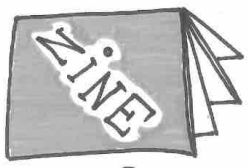

You made a zine!

6

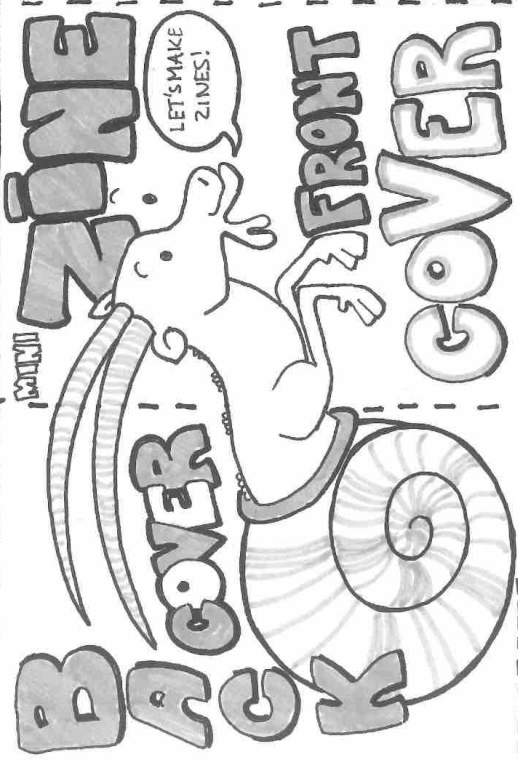

KNOW